



Step into a world of innovative textile
and discover the difference with
SINARA TEX.



CORPORATE OFFICE: House 15 (Level-3), Road-3, Sector-5, Uttara, Dhaka-1230, Bangladesh
REGISTERED OFFICE: 244, Gawair, Dakshinkhan, Dhaka-1230, Bangladesh
Email: info@sinaratex.com | Phone: +880 16 73 78 16 49



ABOUT SINARA TEX

Our journey in the textile industry began in 1993, when we played key operational roles in some of Bangladesh's leading export-oriented textile mills, both foreign and locally owned.

Leveraging our deep expertise stemming from decades of experience in production and marketing, we formed SINARA TEX, with our business philosophy built on the belief that "Sustainable quality is our standard." We are committed to delivering dynamic, reliable service, and we strive to exceed your expectations every step of the way.



Bangladesh spends more than
\$3.0bn for importing cotton

Our Mission

At SINARA TEX, our mission is to be Bangladesh's most revolutionary business house, supplying the finest, premium textiles to consumers around the globe while adhering to the highest ethical standards.



Our Vision

SINARA TEX is dedicated to continuously sourcing, innovating, and managing state-of-the-art technology to provide textiles that meet the most stringent standards of sustainable quality, enabling us to achieve and surpass our mission.

Our Values

- ❑ **Respect:** We honor diversity and treat everyone with dignity.
- ❑ **Ownership:** We are accountable for our actions and relentlessly pursue excellence.
- ❑ **Trust:** We foster trust through open communication and transparency.
- ❑ **Integrity:** We uphold the highest standards of ethical conduct.



Our Buyers



Reitmans



CORPORATE OFFICE: House 15 (Level-3), Road-3, Sector-5, Uttara, Dhaka-1230, Bangladesh
REGISTERED OFFICE: 244, Gawair, Dakshinkhan, Dhaka-1230, Bangladesh
Email: info@sinaratex.com | Phone: +880 16 73 78 16 49

Our Machineries

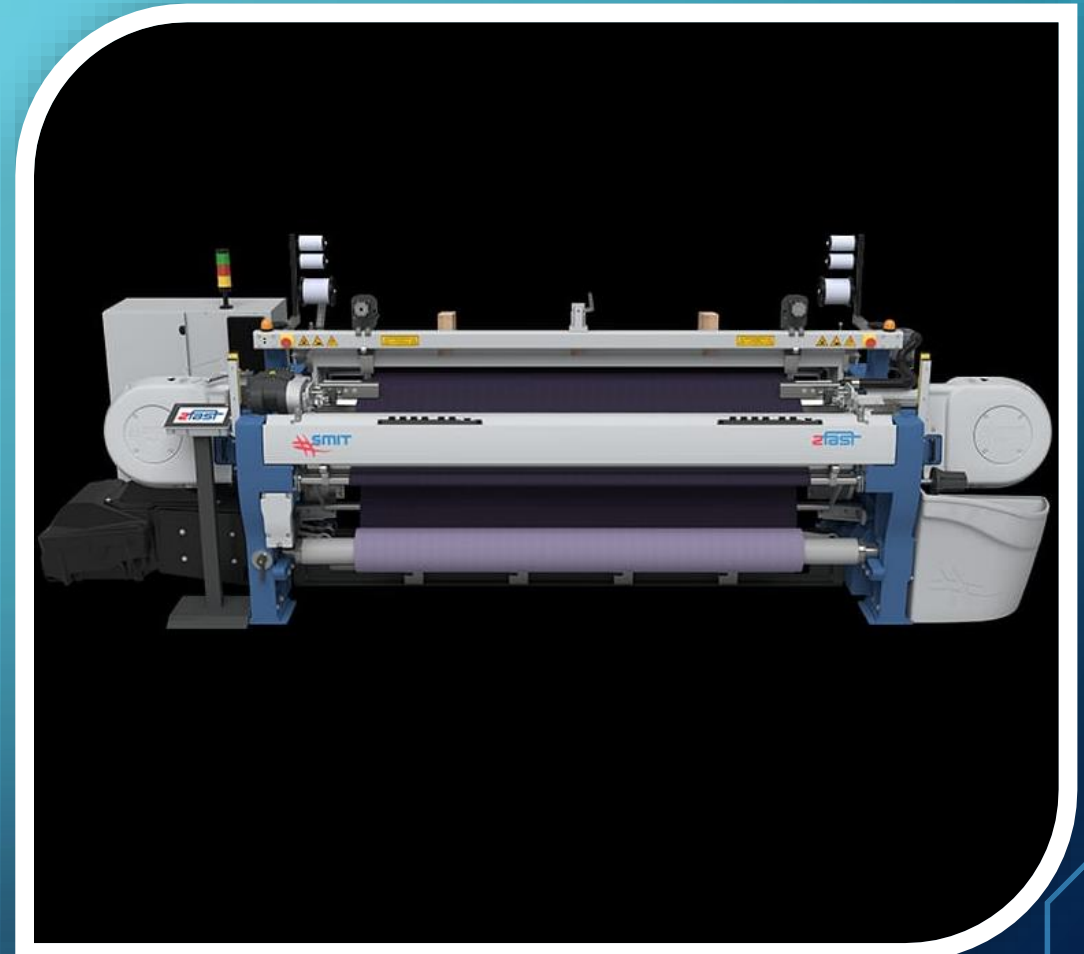

CORPORATE OFFICE: House 15 (Level-3), Road-3, Sector-5, Uttara, Dhaka-1230, Bangladesh
REGISTERED OFFICE: 244, Gawair, Dakshinkhan, Dhaka-1230, Bangladesh
Email: info@sinaratex.com | Phone: +880 16 73 78 16 49

Our **Machineries**



CORPORATE OFFICE: House 15 (Level-3), Road-3, Sector-5, Uttara, Dhaka-1230, Bangladesh
REGISTERED OFFICE: 244, Gawair, Dakshinkhan, Dhaka-1230, Bangladesh
Email: info@sinaratex.com | Phone: +880 16 73 78 16 49

Product Categories

- Woven.
- Non-Woven
- Denim
- Jute Goods



Our Products

Welcome to our product section, where we proudly showcase fabrics of exceptional versatility and quality. At SINARA TEX, we believe that the foundation of every garment lies in its fabric; and that's why we meticulously craft products that serve as the cornerstone of high-end apparel for both men's and women's fashion. Our fabrics are not just materials; they embody our commitment to excellence and innovation. Whether it's luxurious cotton blends or durable polyester compositions, each fabric is crafted to meet the highest standards of quality, comfort, and style.

Whether you're in search of fabrics for formal wear, casual attire, or athleisure collections, our extensive range offers a diverse selection of textures, weights, and finishes to suit every design aesthetic or application. Experience the unparalleled softness, durability, and adaptability—designed to inspire creativity and elevate your collections. With SINARA TEX, you can trust that each piece of fabric is meticulously crafted to exceed your expectations and stand the test of time.

Our Products

Products by Yarn:



100% Cotton



100% Linen



Viscose



Linen Viscose



Modal



Lycra/
Spandex/
Stretch.



Slub

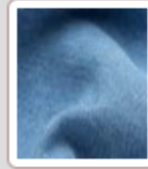

Tencel
(Lyocell) and
Blends

Products by Weave:



Plain



Twill



Oxford



Matt



Herringbone



Bedford Cord



Chambray



Ribstop



Voile



Flannel

Our Products

Products by Weave:



Satin



Cavalry

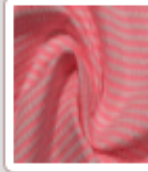

Seersucker

Products by Process and Finish:



Reactive



Pigment



Disperse



VAT

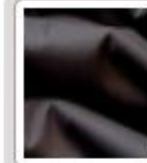

Discharge



Fluorescent



Rotary Print



Flatbed Print



Digital Print



Regular Soft



RFD/PFD



Easy Care



Mercerized



Water/Oil/Soil
Repellent



Moisture
Management

Products by Process & Finish:

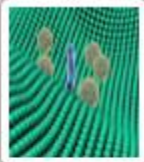

Anti-Microbial



Hydrophilic



Hydrophobic



Peach



Diamond
Peach



Ceramic Brush



Non-Singed
Power Cotton

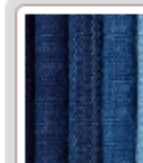

Indigo



Silky Soft

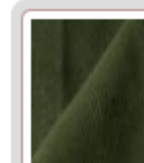

Paper Touch

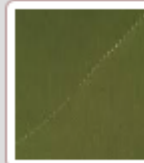

Carbon Brush

Our Products



CORPORATE OFFICE: House 15 (Level-3), Road-3, Sector-5, Uttara, Dhaka-1230, Bangladesh
REGISTERED OFFICE: 244, Gawair, Dakshinkhan, Dhaka-1230, Bangladesh
Email: info@sinaratex.com | Phone: +880 16 73 78 16 49

Our Products

Yarn Dyed



CORPORATE OFFICE: House 15 (Level-3), Road-3, Sector-5, Uttara, Dhaka-1230, Bangladesh
REGISTERED OFFICE: 244, Gawair, Dakshinkhan, Dhaka-1230, Bangladesh
Email: info@sinaratex.com | Phone: +880 16 73 78 16 49

Our Products



Yarn Dyed

CORPORATE OFFICE: House 15 (Level-3), Road-3, Sector-5, Uttara, Dhaka-1230, Bangladesh
REGISTERED OFFICE: 244, Gawair, Dakshinkhan, Dhaka-1230, Bangladesh
Email: info@sinaratex.com | Phone: +880 16 73 78 16 49

Our Products

Yarn Dyed



CORPORATE OFFICE: House 15 (Level-3), Road-3, Sector-5, Uttara, Dhaka-1230, Bangladesh
REGISTERED OFFICE: 244, Gawair, Dakshinkhan, Dhaka-1230, Bangladesh
Email: info@sinaratex.com | Phone: +880 16 73 78 16 49

Our Products



Denim

CORPORATE OFFICE: House 15 (Level-3), Road-3, Sector-5, Uttara, Dhaka-1230, Bangladesh
REGISTERED OFFICE: 244, Gawair, Dakshinkhan, Dhaka-1230, Bangladesh
Email: info@sinaratex.com | Phone: +880 16 73 78 16 49

Our Products



CORPORATE OFFICE: House 15 (Level-3), Road-3, Sector-5, Uttara, Dhaka-1230, Bangladesh
REGISTERED OFFICE: 244, Gawair, Dakshinkhan, Dhaka-1230, Bangladesh
Email: info@sinaratex.com | Phone: +880 16 73 78 16 49

Jute Bags



Our Products

Printed



CORPORATE OFFICE: House 15 (Level-3), Road-3, Sector-5, Uttara, Dhaka-1230, Bangladesh
REGISTERED OFFICE: 244, Gawair, Dakshinkhan, Dhaka-1230, Bangladesh
Email: info@sinaratex.com | Phone: +880 16 73 78 16 49

Our Products

Lycra/Spandex Twill



CORPORATE OFFICE: House 15 (Level-3), Road-3, Sector-5, Uttara, Dhaka-1230, Bangladesh
REGISTERED OFFICE: 244, Gawair, Dakshinkhan, Dhaka-1230, Bangladesh
Email: info@sinaratex.com | Phone: +880 16 73 78 16 49

Our Products

Corduroy



CORPORATE OFFICE: House 15 (Level-3), Road-3, Sector-5, Uttara, Dhaka-1230, Bangladesh
REGISTERED OFFICE: 244, Gawair, Dakshinkhan, Dhaka-1230, Bangladesh
Email: info@sinaratex.com | Phone: +880 16 73 78 16 49

Our Products

Stripe Printed

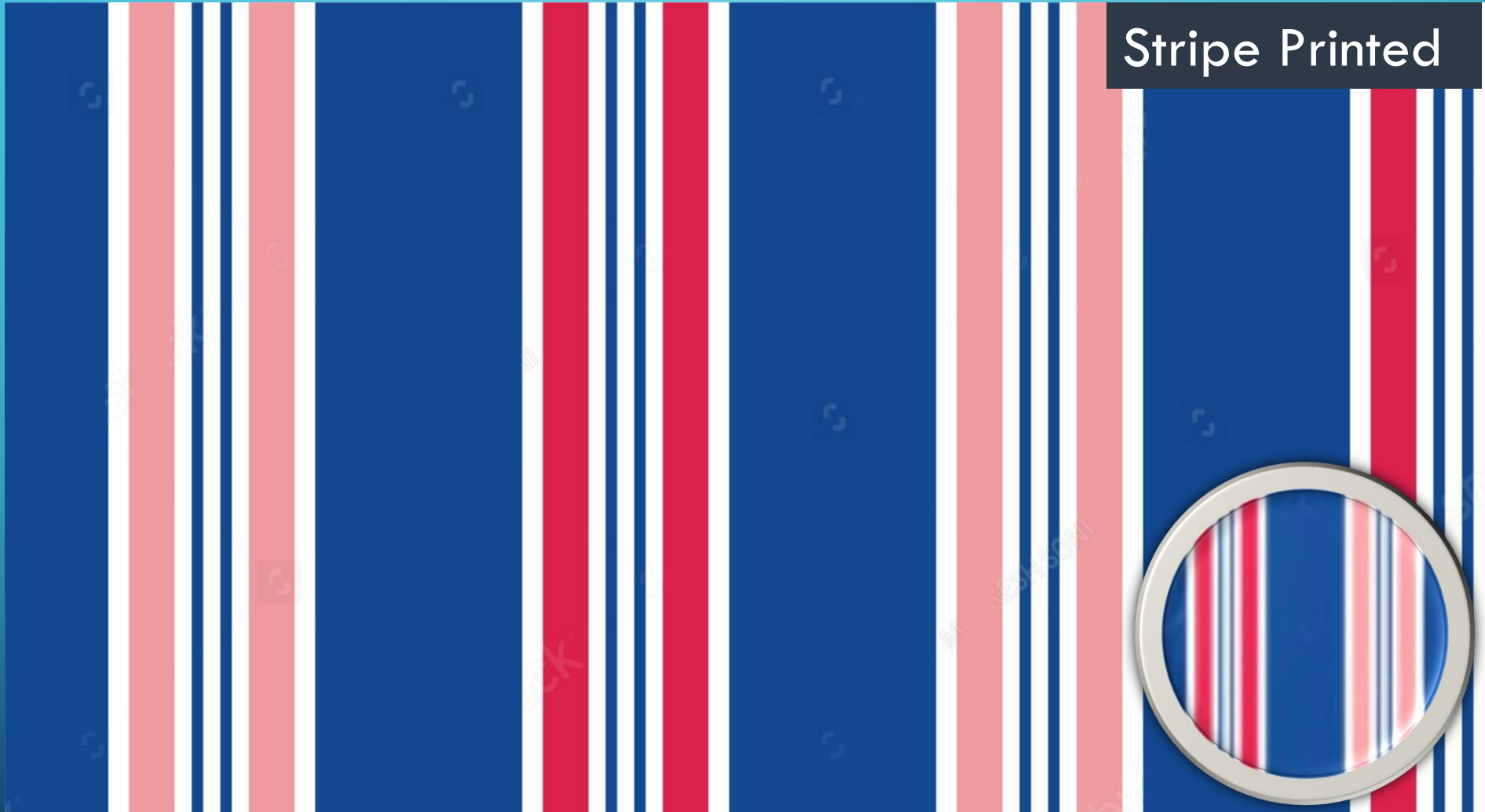

CORPORATE OFFICE: House 15 (Level-3), Road-3, Sector-5, Uttara, Dhaka-1230, Bangladesh
REGISTERED OFFICE: 244, Gawair, Dakshinkhan, Dhaka-1230, Bangladesh
Email: info@sinaratex.com | Phone: +880 16 73 78 16 49

Our Products

Printed



CORPORATE OFFICE: House 15 (Level-3), Road-3, Sector-5, Uttara, Dhaka-1230, Bangladesh
REGISTERED OFFICE: 244, Gawair, Dakshinkhan, Dhaka-1230, Bangladesh
Email: info@sinaratex.com | Phone: +880 16 73 78 16 49

Our Products



Wrinkle-free

CORPORATE OFFICE: House 15 (Level-3), Road-3, Sector-5, Uttara, Dhaka-1230, Bangladesh
REGISTERED OFFICE: 244, Gawair, Dakshinkhan, Dhaka-1230, Bangladesh
Email: info@sinaratex.com | Phone: +880 16 73 78 16 49

 **Sinaratex**

Our Products

Denim



CORPORATE OFFICE: House 15 (Level-3), Road-3, Sector-5, Uttara, Dhaka-1230, Bangladesh
REGISTERED OFFICE: 244, Gawair, Dakshinkhan, Dhaka-1230, Bangladesh
Email: info@sinaratex.com | Phone: +880 16 73 78 16 49

Raw Denim



Stone Wash



Bleach Wash



Vintage Wash

Enzyme Wash

Our Products

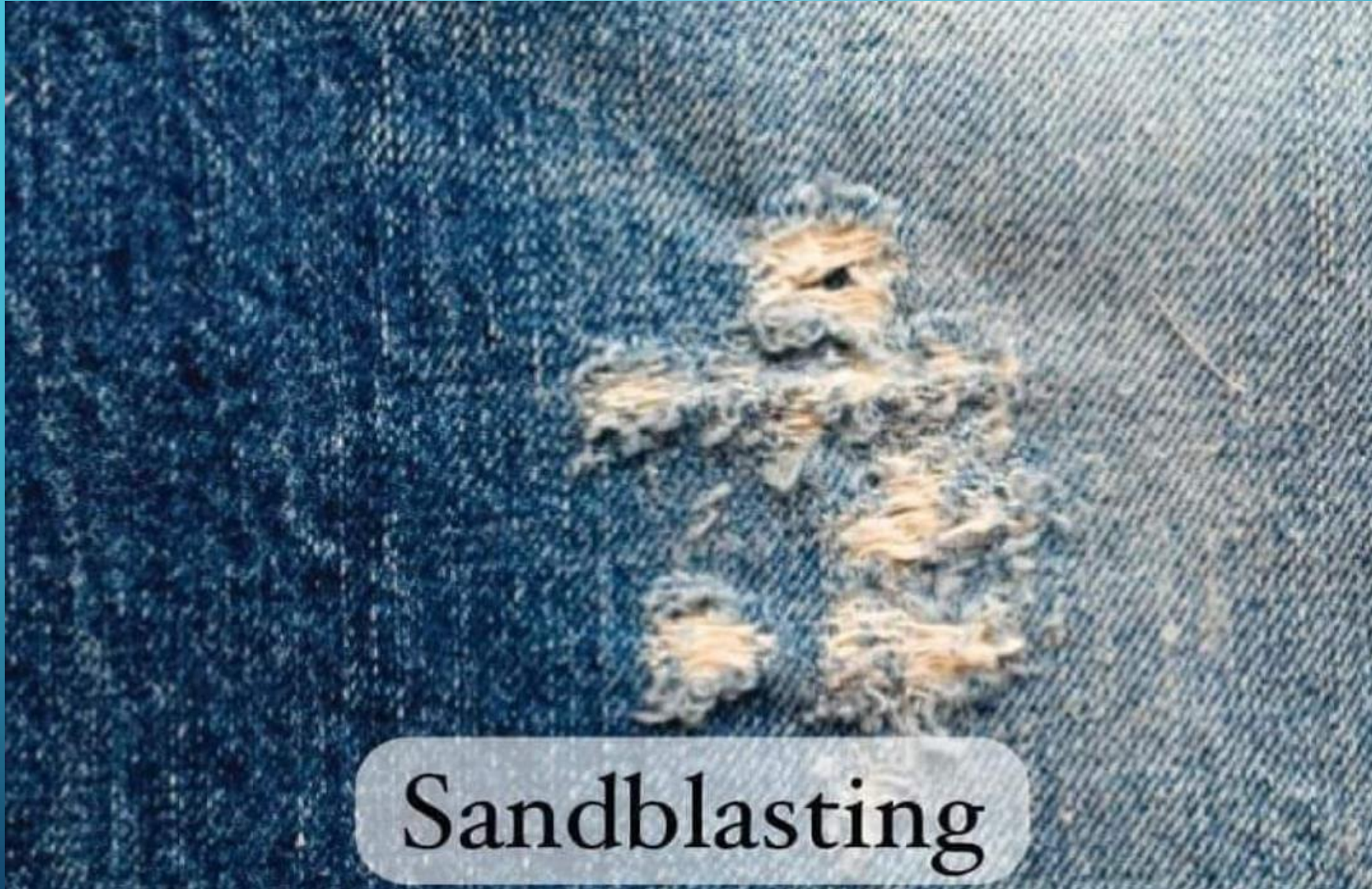

Sandblasting

CORPORATE OFFICE: House 15 (Level-3), Road-3, Sector-5, Uttara, Dhaka-1230, Bangladesh
REGISTERED OFFICE: 244, Gawair, Dakshinkhan, Dhaka-1230, Bangladesh
Email: info@sinaratex.com | Phone: +880 16 73 78 16 49

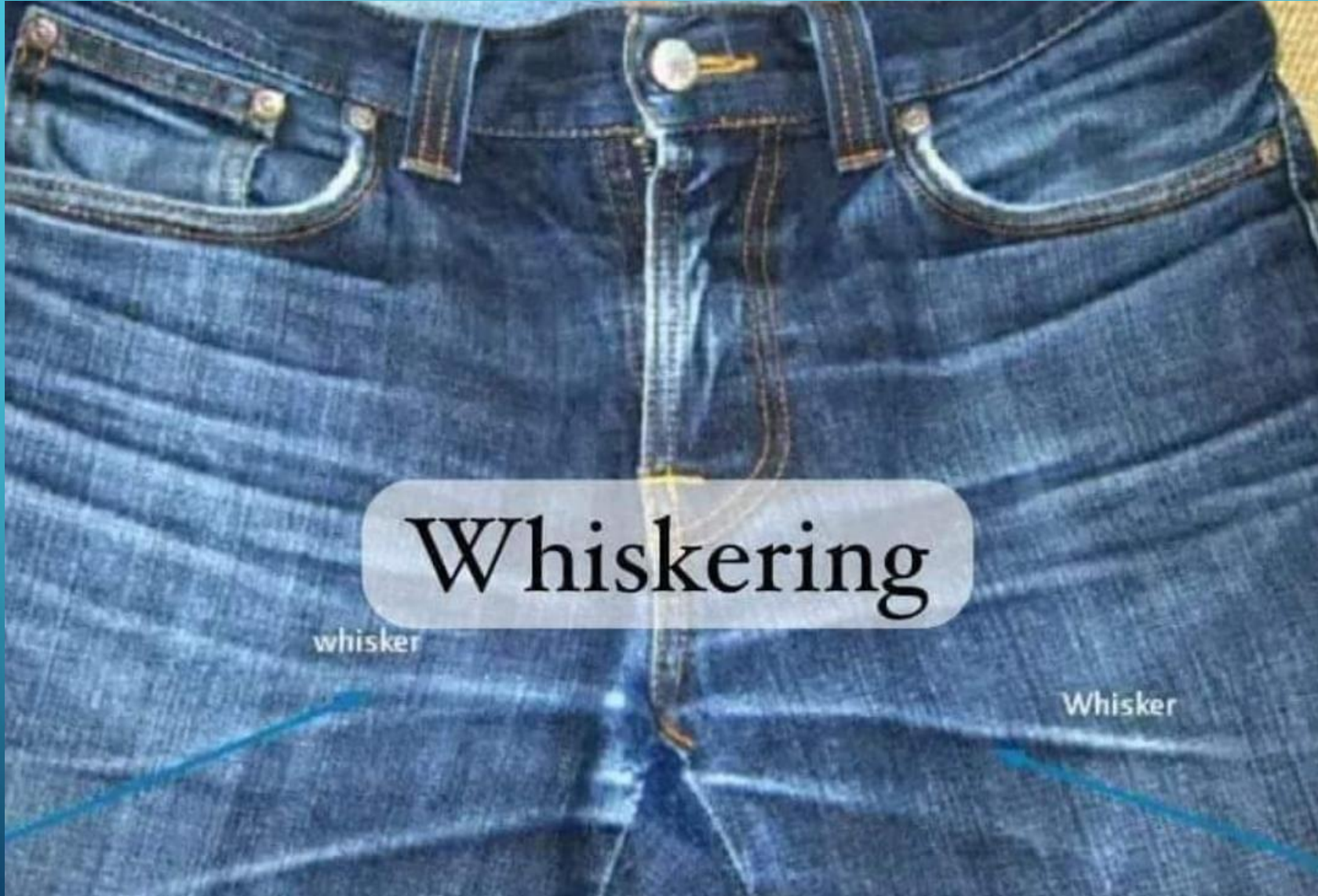

Whiskering

whisker

Whisker

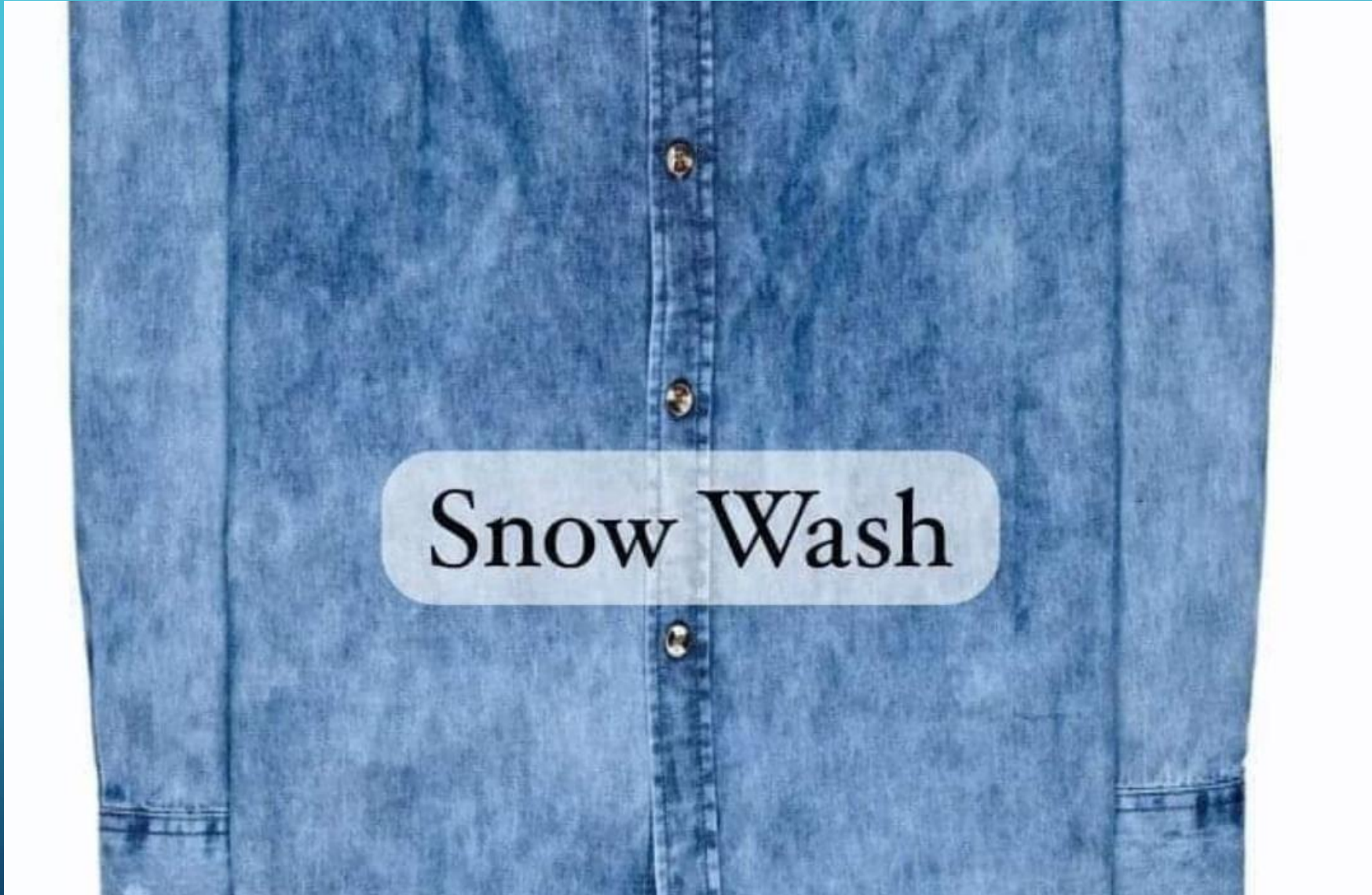

Snow Wash

Our Products

Camo



CORPORATE OFFICE: House 15 (Level-3), Road-3, Sector-5, Uttara, Dhaka-1230, Bangladesh
REGISTERED OFFICE: 244, Gawair, Dakshinkhan, Dhaka-1230, Bangladesh
Email: info@sinaratex.com | Phone: +880 16 73 78 16 49

Our Products

Water Repellent

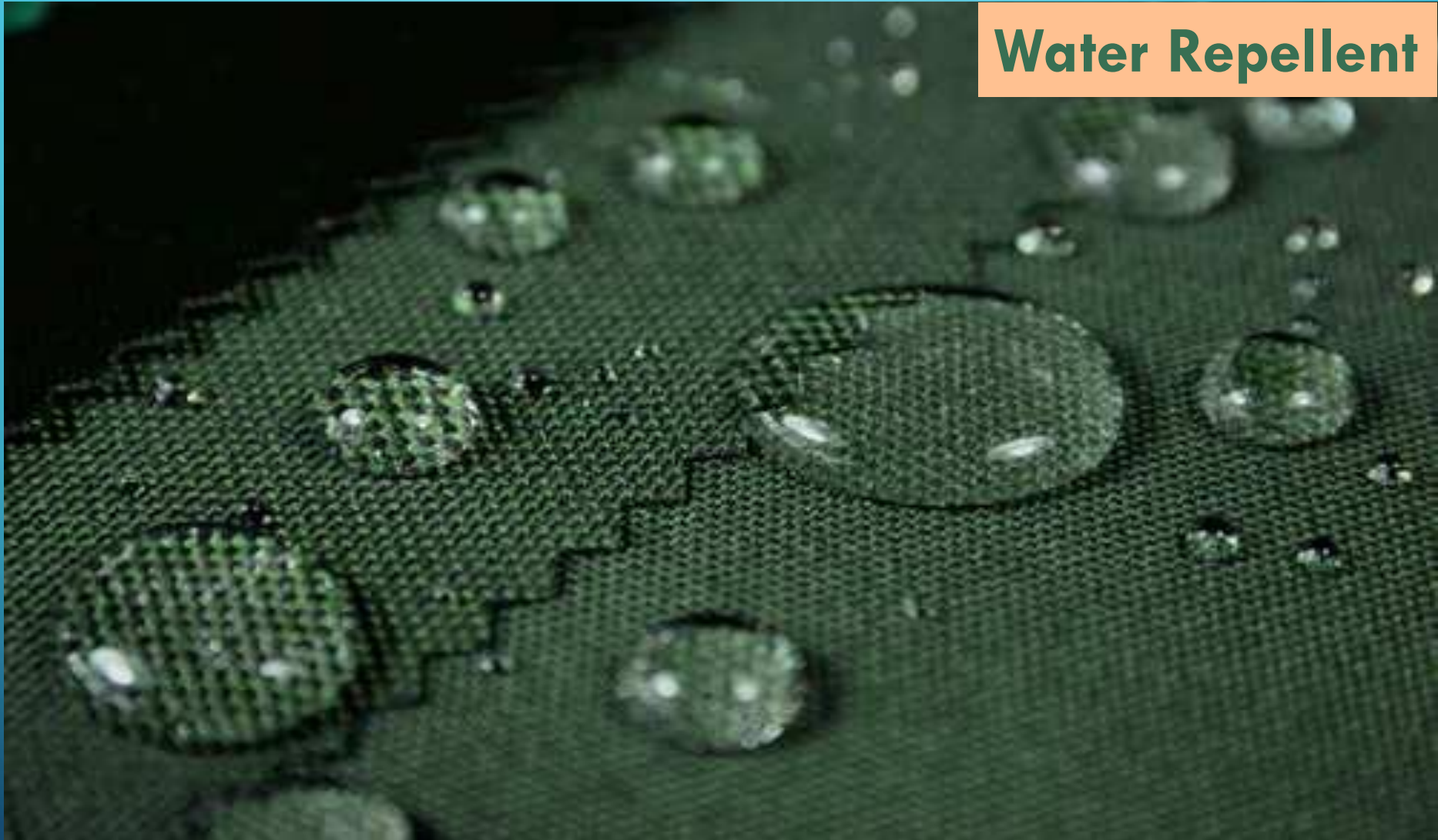

CORPORATE OFFICE: House 15 (Level-3), Road-3, Sector-5, Uttara, Dhaka-1230, Bangladesh
REGISTERED OFFICE: 244, Gawair, Dakshinkhan, Dhaka-1230, Bangladesh
Email: info@sinaratex.com | Phone: +880 16 73 78 16 49

Our Products



612239
75% BCI Cotton 25% Jute
54x50/15CJx15CJ
Plain; 56/57"
Mercerized+Soft+Calendering
Dark Black
GSM: 160 (+5%)

Our Products



Innovation in Cotton-Jute Blend Yarn and Woven Fabric



S2425749
75% BCI Cotton 25% Jute
54x50/15CJx15CJ
Plain; 56/57"
Mercerized+Soft+Calendering
GSM: 158(±5%)

Unique texture and natural appearance



S2425752
75% BCI Cotton 25% Jute
58x46/15CJx15CJ
Plain; 56/57"
GSM: 159 ($\pm 5\%$)
Mercerized+Soft+Calendering



Our Products

612240
75% BCI Cotton 25% Jute
70x54/21CJx21CJ
Plain; 56/57"
Mercerized+Soft+Calendering
GSM: 130 ($\pm 5\%$)

500,245
612242
75% BCI Cotton 25% Jute
60x50/21CJx21CJ
Plain; 56/57"
Mercerized+Soft+Calendering
GSM: 117 ($\pm 5\%$)

612243
75% BCI Cotton 25% Jute
62x56/21CJx21CJ
Plain; 56/57"
Mercerized+Soft+Calendering
GSM: 132 ($\pm 5\%$)



Importance of Yarn Processing

- ❑ Enhancing Fiber Quality.
- ❑ **Elongation:** Enhances flexibility and durability of the yarn.
- ❑ **Tear Strength:** Increases resistance to damage and wear.
- ❑ **Itching:** Reduces discomfort and improves user satisfaction



Fabric Manufacturing Process

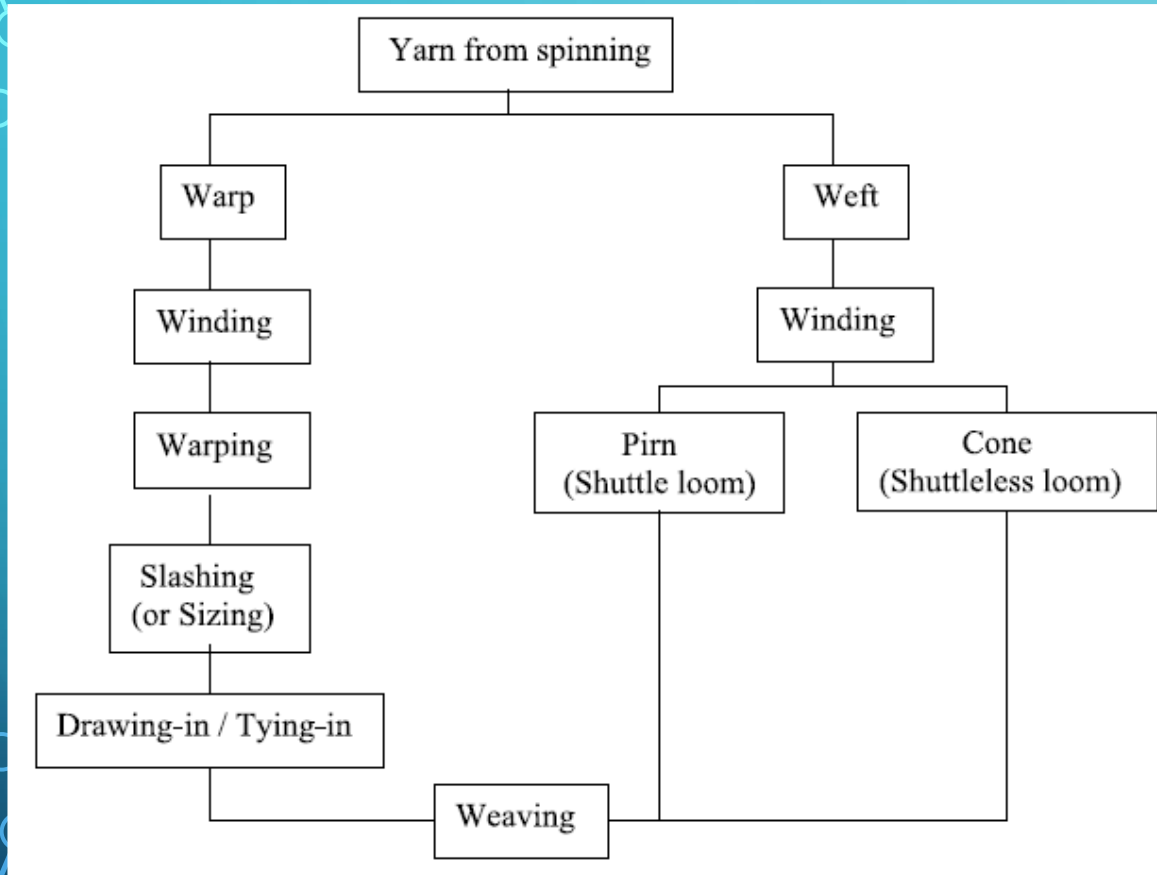

Fabric Processing



Yarn dyeing



Weaving



Finishing Process



Inspection



Innovation in Cotton-Jute Blended Yarn and Woven Fabric

Enhancing Sustainability and Performance in Textiles

Blend: 75% Cotton, 25% Jute

Combining the benefits of both fibers to
create a versatile and sustainable textile

Our Certification



CIMA



CORPORATE OFFICE: House 15 (Level-3), Road-3, Sector-5, Uttara, Dhaka-1230, Bangladesh
REGISTERED OFFICE: 244, Gawair, Dakshinkhan, Dhaka-1230, Bangladesh
Email: info@sinaratex.com | Phone: +880 16 73 78 16 49

At SINARA TEX, we are dedicated to delivering innovative, high-quality textiles that meet our customers' needs while promoting ethical, sustainable, and environmentally friendly practices. We strive to stay ahead of the competition, foster innovation and collaborate with experts to deliver the finest textile goods.

Thank you for considering SINARA TEX. We look forward to the opportunity to serve you with the best in textile solutions.

Feel free to reach out to us for any information or inquiries with no hesitation. We look forward to hearing from you.

CORPORATE OFFICE

*House 15 (Level-3), Road-3, Sector-5, Uttara, Dhaka-1230,
Bangladesh*

REGISTERED OFFICE

*244, Gawair, Dakshinkhan, Dhaka-1230,
Bangladesh*

FACTORY

Panchdona, Narsingdi, Bangladesh

CONTACT US: +880 16 73 78 16 49

Service: info@sinaratex.com